

ZiTTO

**WORKPODS
BREAK OUT AREA**



Sound Absorbing Material Integrated into
FUNCTIONAL FURNITURE

ELEMENTS

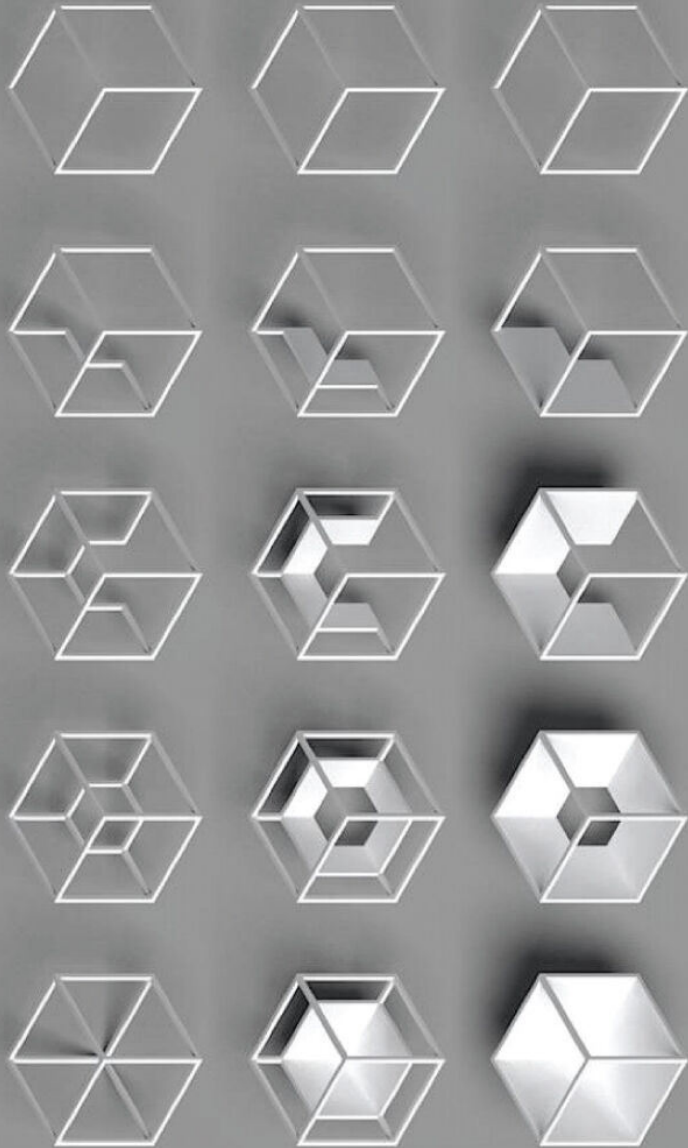

Zitto are straight line panels with angular corners. Inspired by “rectilinear” with a general definition of “geometry”.

The design by performance of the modern offices, technology integration and the direction of organizational change are the driving force behind the Zitto collections.

From traditional workspaces to shared individual workpods or to group spaces, effective space planning can be determine easily by various linear configurations and solutions offered by Zitto.

NOISE

is one of the greatest causes of stress of our times. It surrounds us and puts a strain on our bodies. Our ability to relax and our concentration greatly depend on the acoustic environment in which we **LIVE** and **WORK**. The balance in the acoustics creates a tranquil setting and provides a means to focus on the matter at hand.

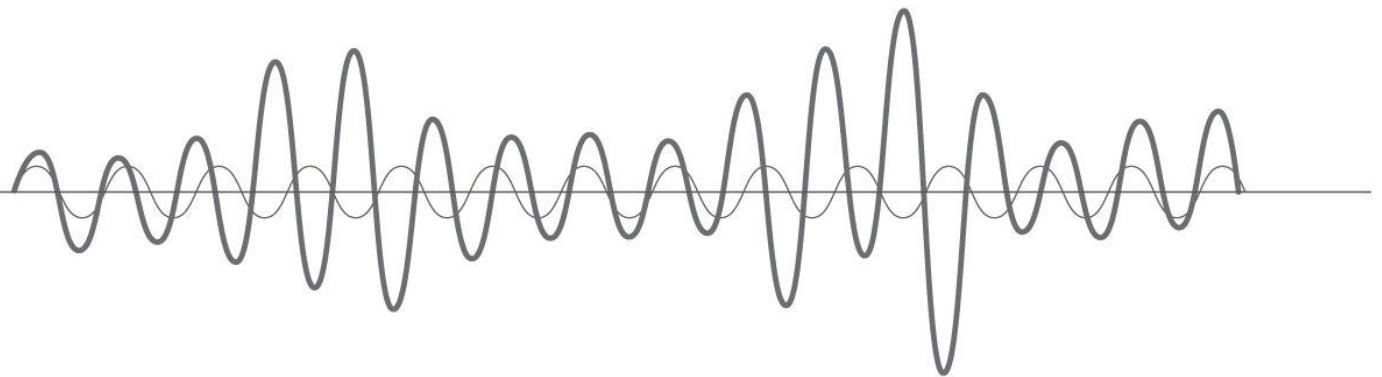

STORY & INSPIRATION



211TD
SPACE DIVIDER
CREATIVITY

· collaboration
· Boho workpod

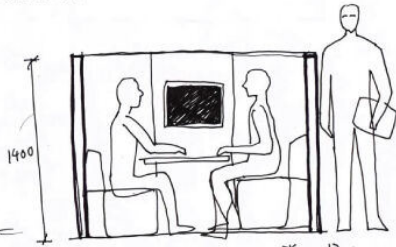

Social Connection

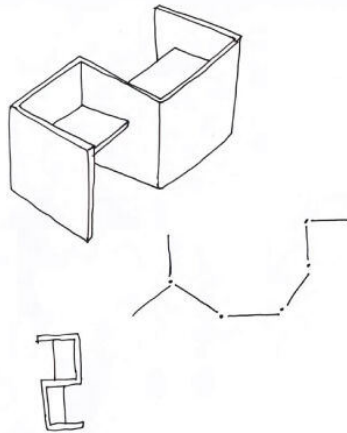
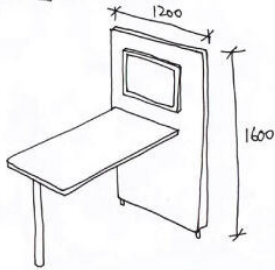

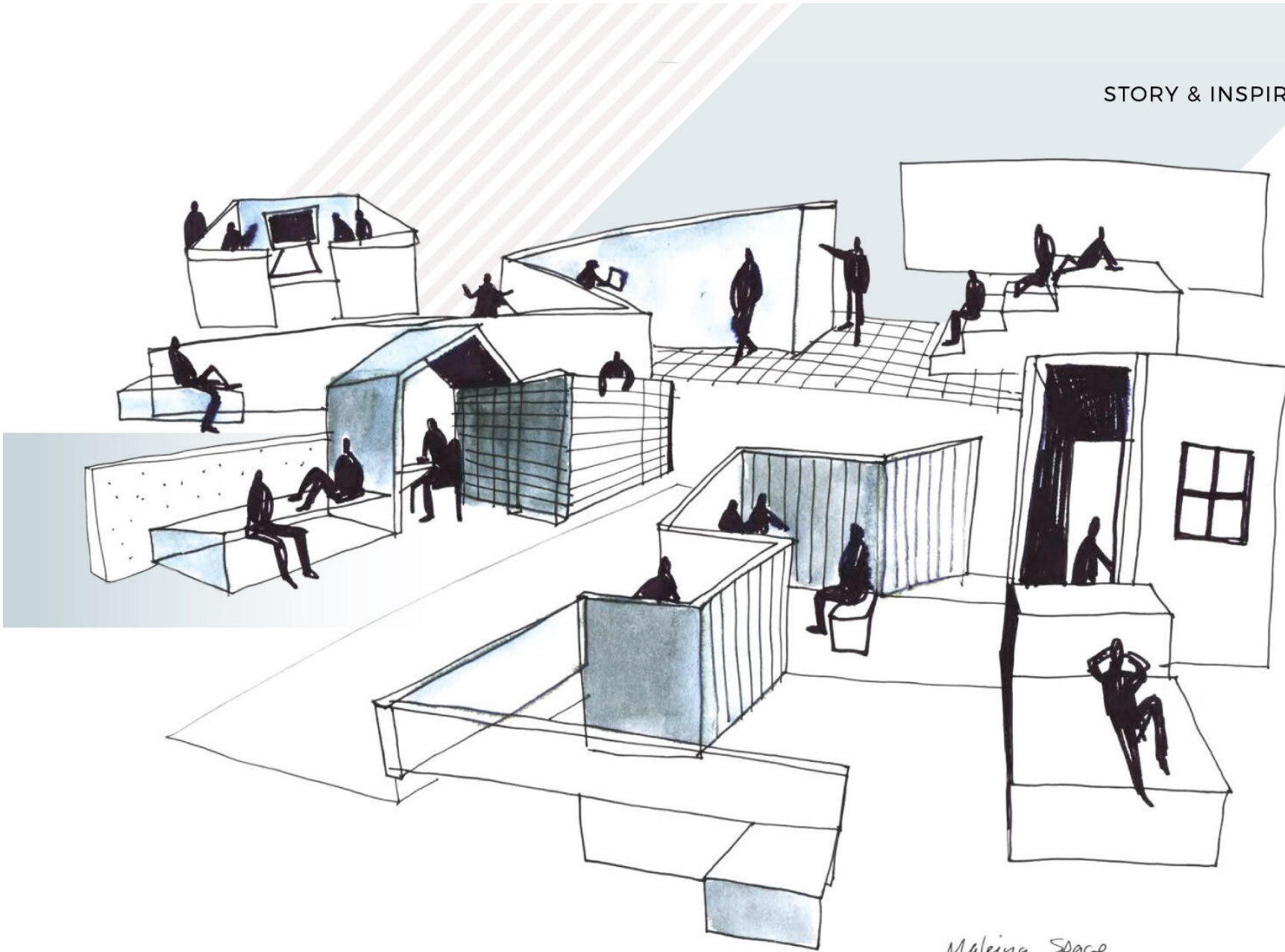

Making Space



Elements which have been

optimized

for sound absorbing properties.

Furniture elements which
have been optimized for

sound absorbing
properties.



The
RIGHT

type of workspace creates
good working environment for
well being.



COLLABORATION

In modern workplace, vast amounts of information needs to be shared, analyzed, distributed and discussed. Workplaces that encourage interaction and collaboration are vital to creating an atmosphere of information sharing, knowledge creation, flexibility and communication.



FLEXIBILITY & FUNCTION



Zitto collection is modern contemporary acoustic furniture using straight shaped acoustic panel system integrated with worktops and seating.



ACHIEVING ACOUSTIC COMFORT IN THE MODERN DAY OFFICE

DID YOU KNOW ?

Lack of sound privacy is the biggest frustration for office worker



60% Of workers **DISSATISFIED** with lack of sound privacy

30% Of Workers find the noise level in the office a **FRUSTRATION**

86 **MINUTES** **LOST EACH DAY** due to unwanted noise distractions



COLLABORATION

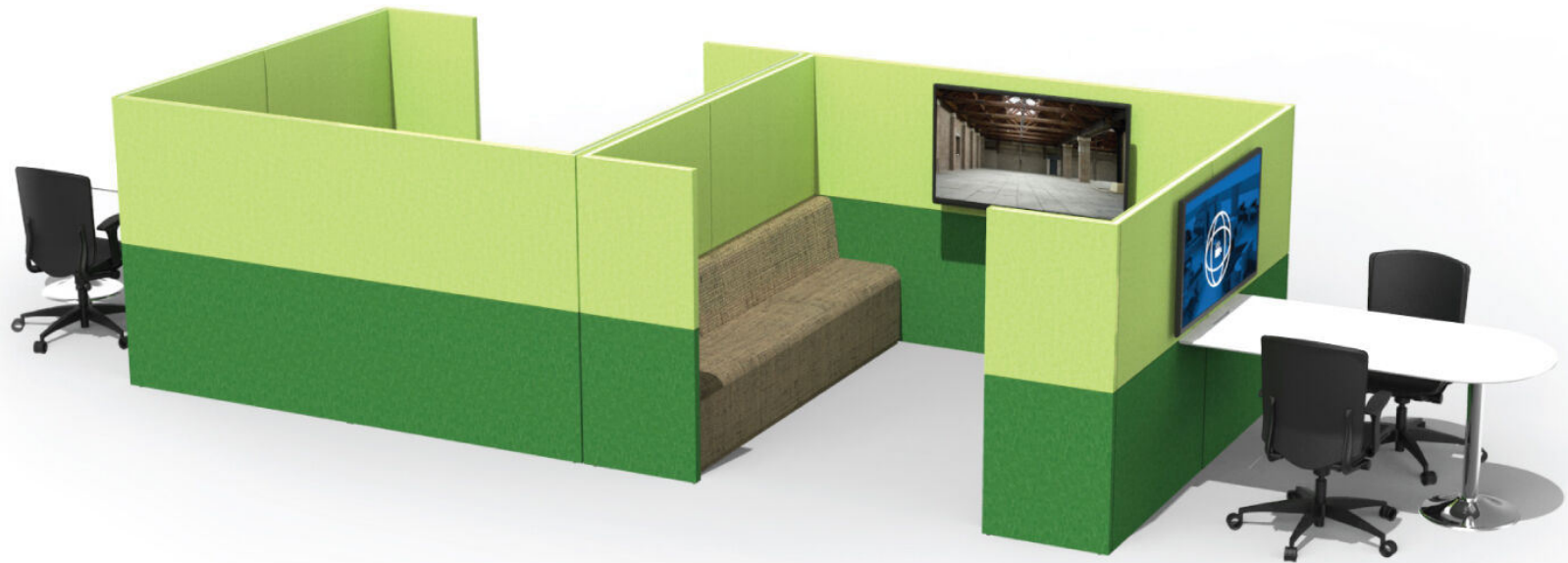



COLLABORATION





SOLO WORK POD



Pre fabricated straight panel boards with a highly acoustic absorbent surface to reduced reverberation in an open space. A well-proven solution where each employee has their own privacy space that will boast their productivity level.



MEDIA WALL POD



HOT DESK





FORM & FUNCTION



FORM & FUNCTION of ZITTO

- Create Privacy
- Contain the Noise
- Beautify the Space
- Strengthen Learning organization
- Modular Units



SPECIFICATION



SOLO WORK POD Z S _ W P 1

Dimension (W x D x H mm)
1200 x 1200 x 1200
1200 x 1200 x 1500

1500 x 1200 x 1200
1500 x 1200 x 1500

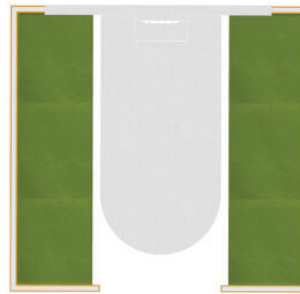

QUAD MEETING POD Z Q _ M E E T 1

Dimension (W x D x H mm)
1900 x 2000 x 1500
1900 x 2400 x 1500

** Zitto quad meeting pod configuration
includes table and bench seating.*

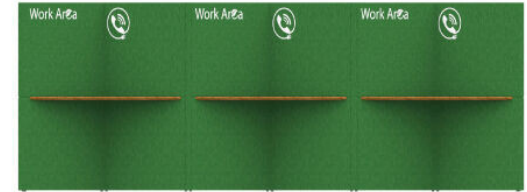

HOT DESK

Dimension (W x D x H mm)
4000 x 750 x 1500

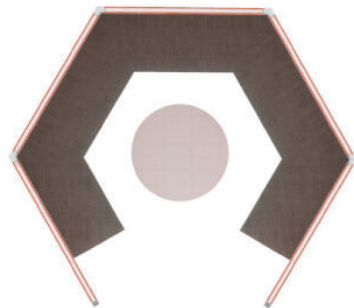

QUAD MEETING POD
ZQ_MEET 2

Dimension (W x D x H mm)
2560 x 2200 x 1500

** Zitto quad meeting pod configuration includes table and bench seating.*



MEDIA WALL

Dimension (W x D x H mm)
1622 X 439 X 1800

ACCESSORIES



P TABLE
Z S C 1 & 2

Dimension (W x D x H mm)
1600 x 800 x 750
2100 x 800 x 750



BENCH
Z S C 3 & 4

Dimension (W x D x H mm)
1900 x 500 x 450
2300 x 500 x 450



ROUND TABLE
G S C 5 & 6

Dimension
750 (Diameter)
900 (Diameter)

ACCESSORIES

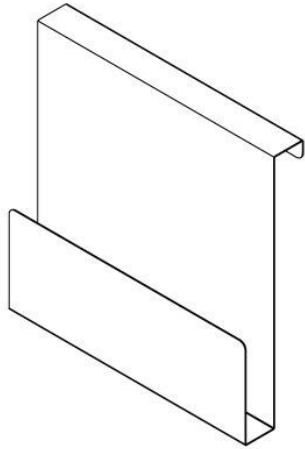

MAGAZINE RACK

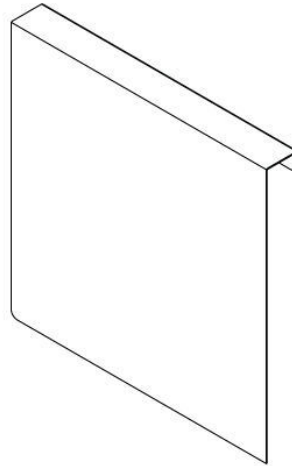

MAGMATIC BOARD

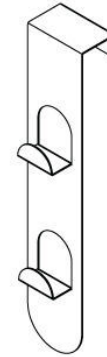

DOUBLE HOOK RACK

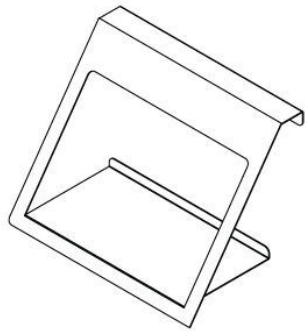

SHELF

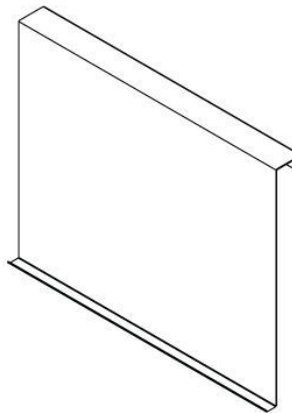

WHITE BOARD



CABLE MANAGEMENT

TECHNICAL INFORMATION



E = 9mm Ekous



PW = PVC White



PB = PVC Black

OPTIONAL EDGING FINISHES

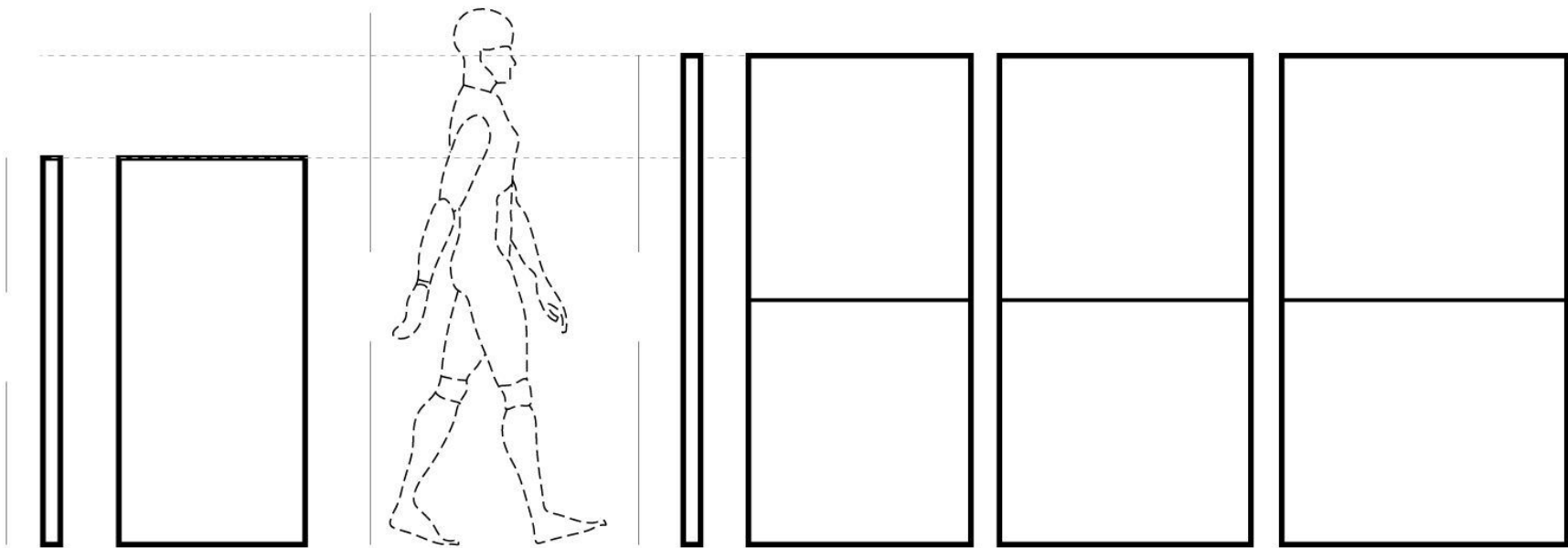



PANEL FOR CHANGE OF HEIGHT

SOUND ABSORPTION

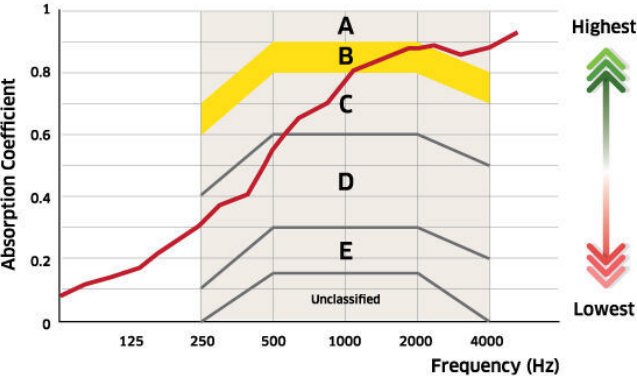

The surface of **ZITTO** is finished with Ekous Sonata where the highly dense fibers greatly improves sound absorption levels across a broad range of frequencies.

Acoustic Performance



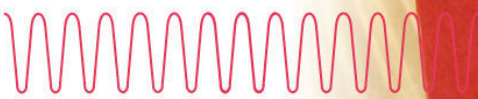

- 

UP TO **81%** high range absorption

- 

UP TO **94%** mid range absorption















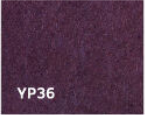

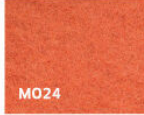



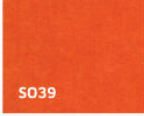

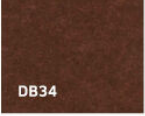

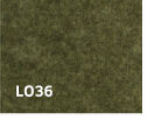
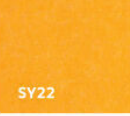

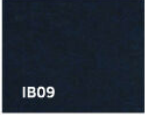
- 

UP TO **55%** low range absorption



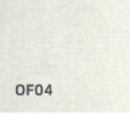

Color Selection (Sonata 9mm)

 OB37 OCEAN BLUE	 SG05 SHINNY GREEN	 SC07 SOFT CREAM	 MR32 MAROON RED	 YP36 YAM PURPLE	 SB29 SKY BLUE
 AG41 APPLE GREEN	 MO24 MANDARIN ORANGE	 RW27 RED WINE	 PP40 PURE PURPLE	 SB40 SEA BLUE	 GG14 GRASS GREEN
 SO39 SWEETY ORANGE	 SR15 SPECTRUM RED	 DB34 DARK BROWN	 BB21 BRIGHT BLUE	 LO36 LIGHT OAK	 SY22 SMART YELLOW
 HR31 HOT RED	 DC02 DARK CAMEL	 IB09 INDIGO BLUE	 DB35 DARK BRONZE	 SY18 SUNNY YELLOW	 SG03 SILVER GREY
 LC01 LIGHT CAMEL	 CH17 CHARCOAL	 DG19 DARK GREEN	 MY31 MILKY YELLOW	 DG37 DEEP GREY	 OF04 OFF WHITE
 PB10 PURE BLACK					

Variation in fiber mix and color is an inherent feature of this product. Variation from batch to batch may occur. Products will be supplied within commercial tolerance.

CERTIFICATIONS

Environment



Green Label :
Environmentally Improved Low Emission,
Low Toxicity, Certified

Health & Safety



SGS :
- Formaldehyde Free
- Toulene Test
- RoHS Test



TUV :
- Low VOC
- Fire Test (BS476 Part 7)
(Class 1Y) - Surface Flame Spread

Acoustic Performance



Acoustic Facts :
Ekous have been certified and evaluated
independently by Acoustic facts.

Our product has been certified, evaluated and
broadcasted by Acoustic Facts using Swedish
Standard SS25269, that gives credibility for the
use of the product throughout the design
process.

SWEDEN \ MALAYSIA \ THAILAND \ SINGAPORE \ INDIA \ PHILIPPINES \ HONG KONG
INDONESIA \ AUSTRALIA

EKOUS MALAYSIA

13-1 to 13-6, Block F1,
Jalan PJU 1/42, Dataran Prima,
47301, Petaling Jaya,
Selangor. Malaysia.

T + 6 03 7804 9111
F + 6 03 7804 0111

